

MODEL
DLx1200
1200lb/544kg CAPACITY
PULLING WINCH

FRONT & SIDE VIEW

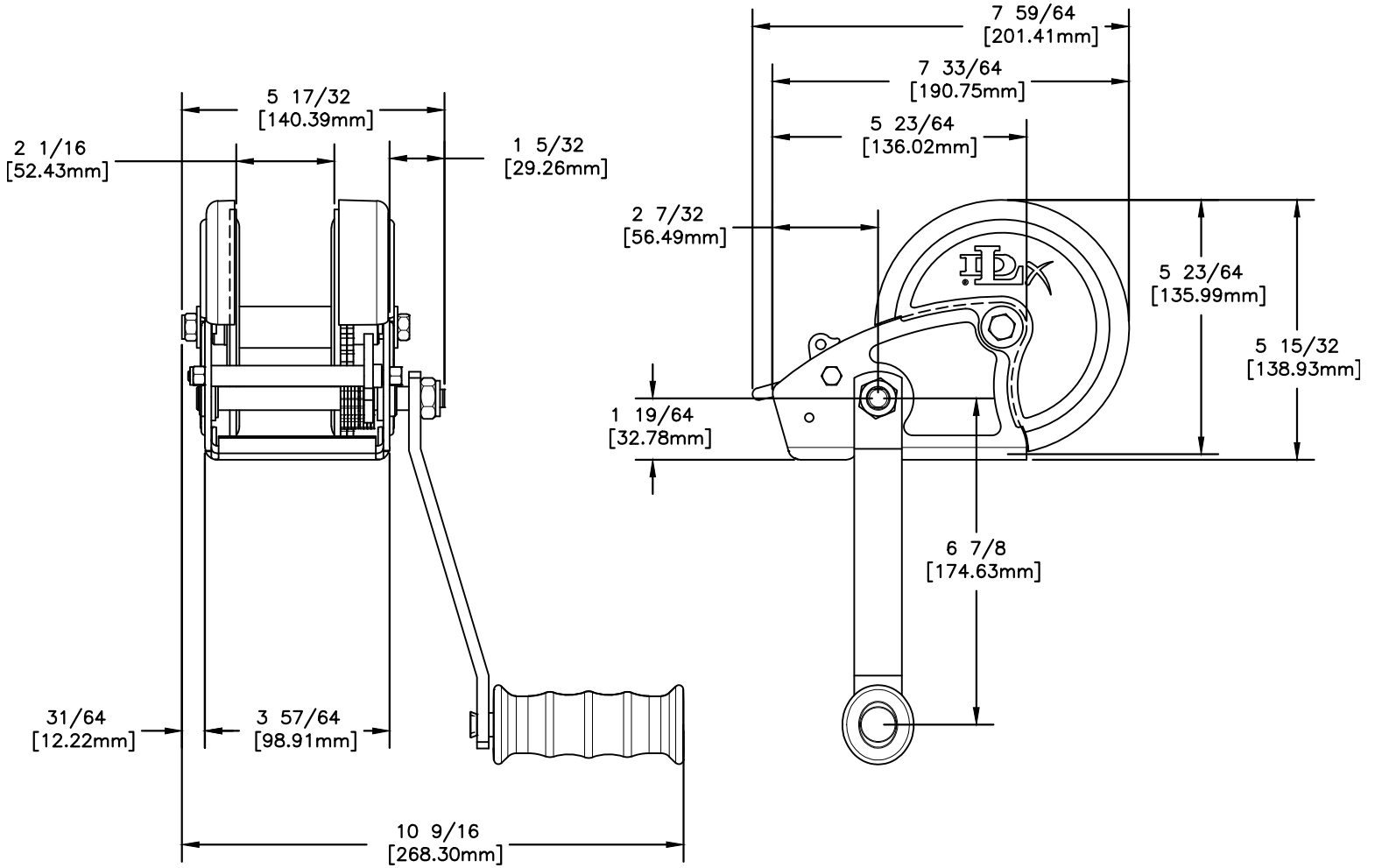

BASE HOLE PATTERN

