

MODEL
DLC2500
2500lb/1134kg CAPACITY
PULLING WINCH

FRONT & SIDE VIEW

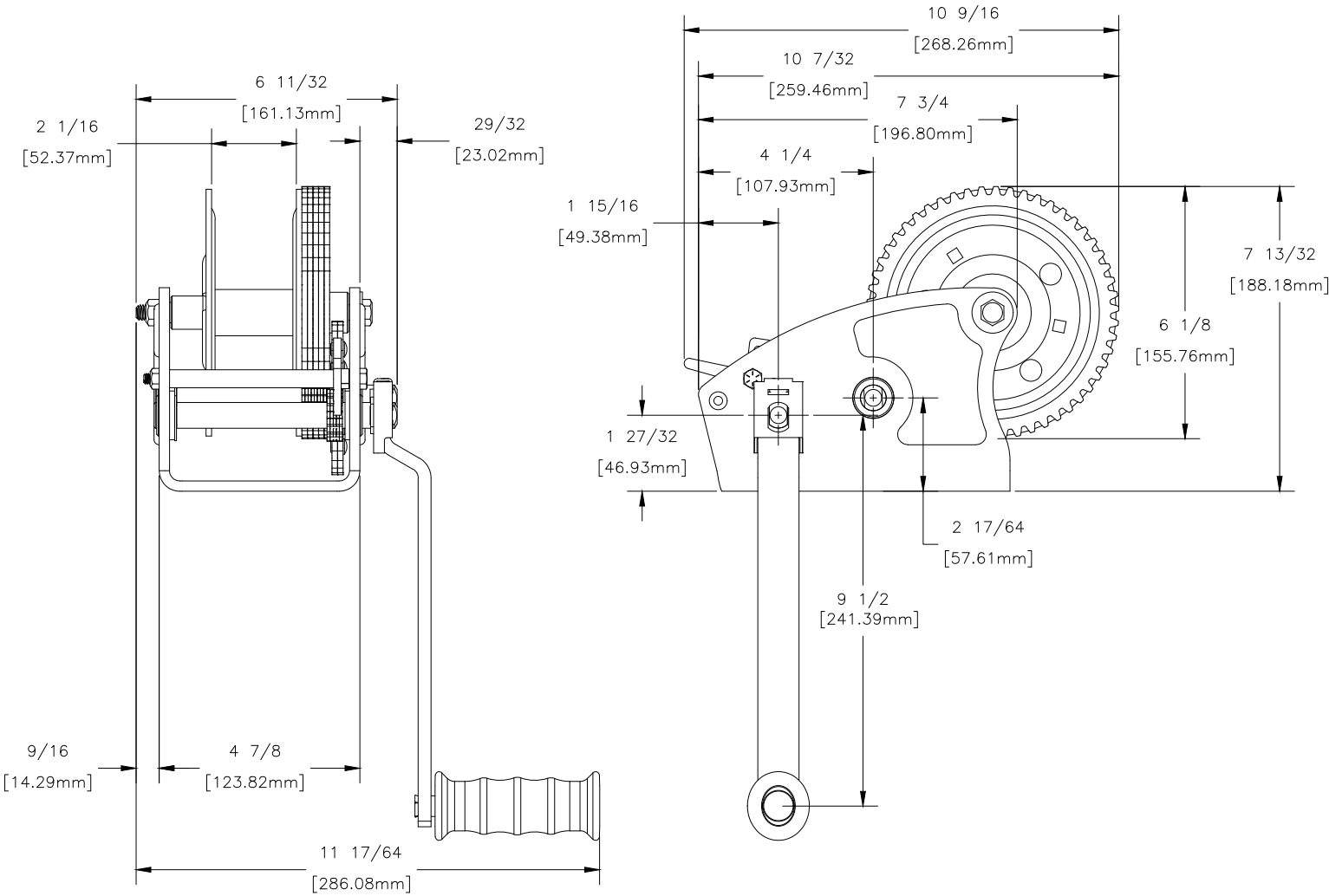

BASE HOLE PATTERN

