

MODEL
DLC1100

1100lb/499kg CAPACITY
PULLING WINCH

FRONT & SIDE VIEW

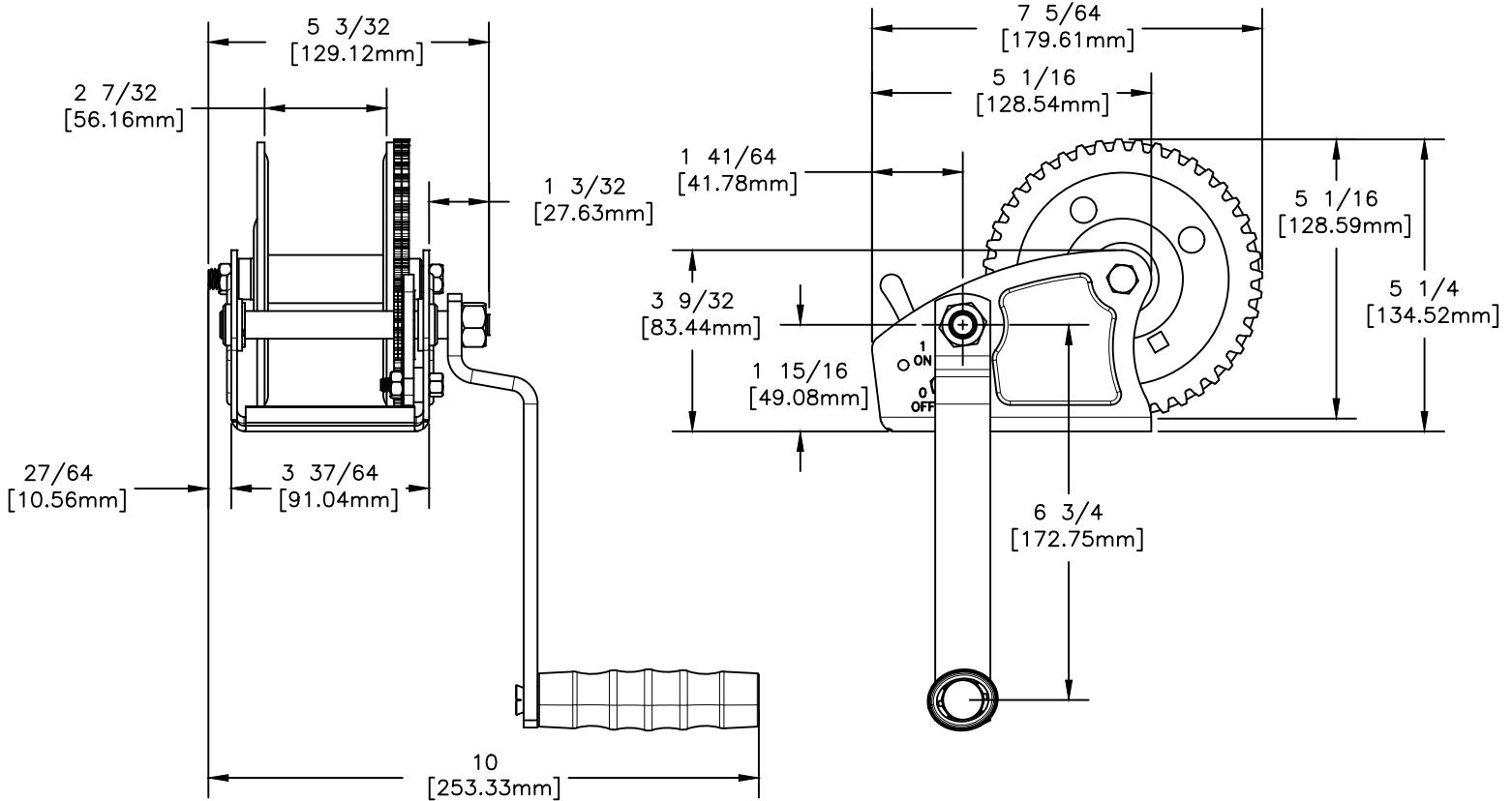

BASE HOLE PATTERN

