

FRONT & SIDE VIEW

MODEL DL2000A
2000lb/908kg CAPACITY
PULLING WINCH

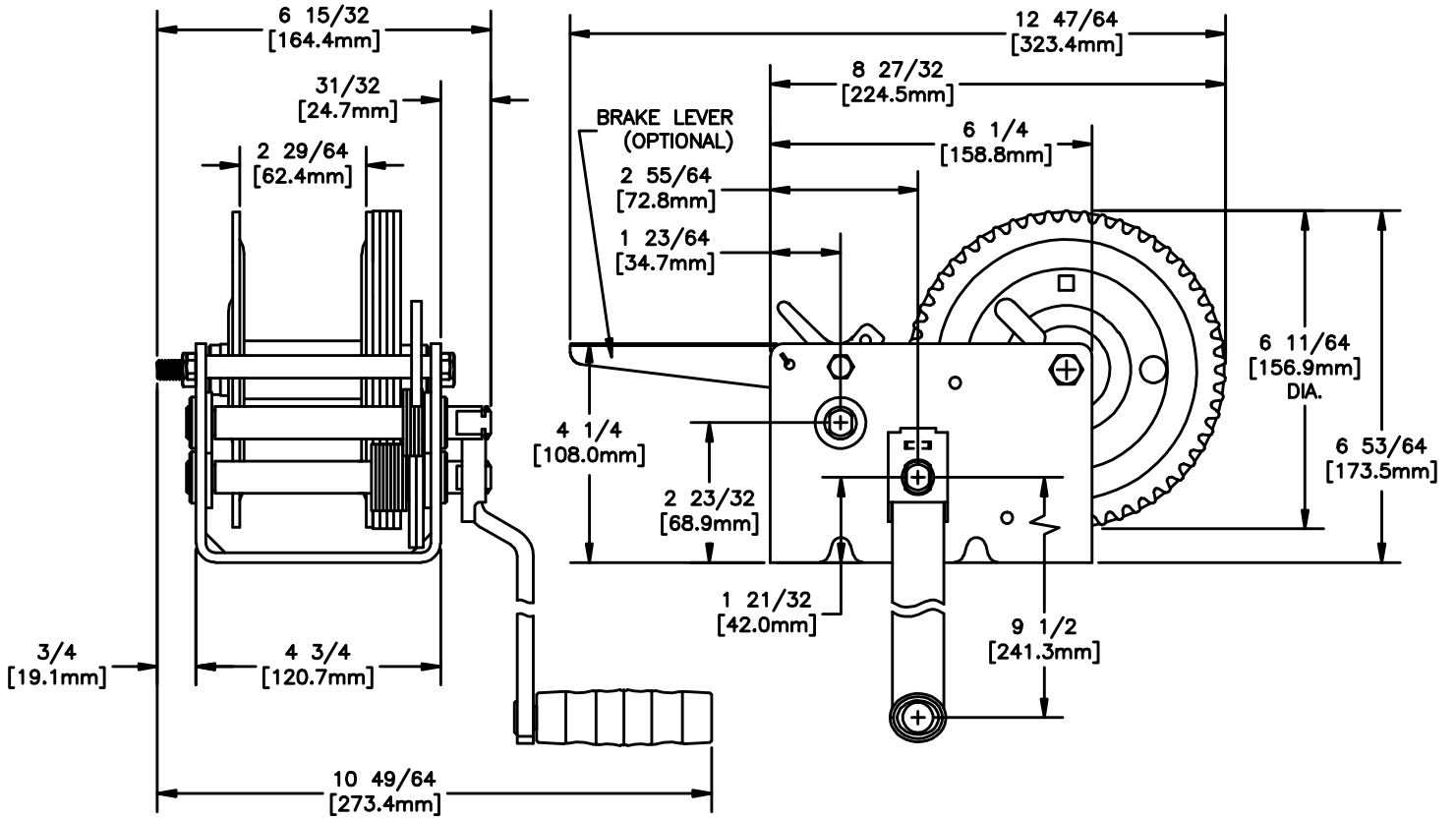

BASE HOLE PATTERN

