

FRONT & SIDE VIEW

MODEL DL1602A  
1600lb/726kg CAPACITY  
PULLING WINCH

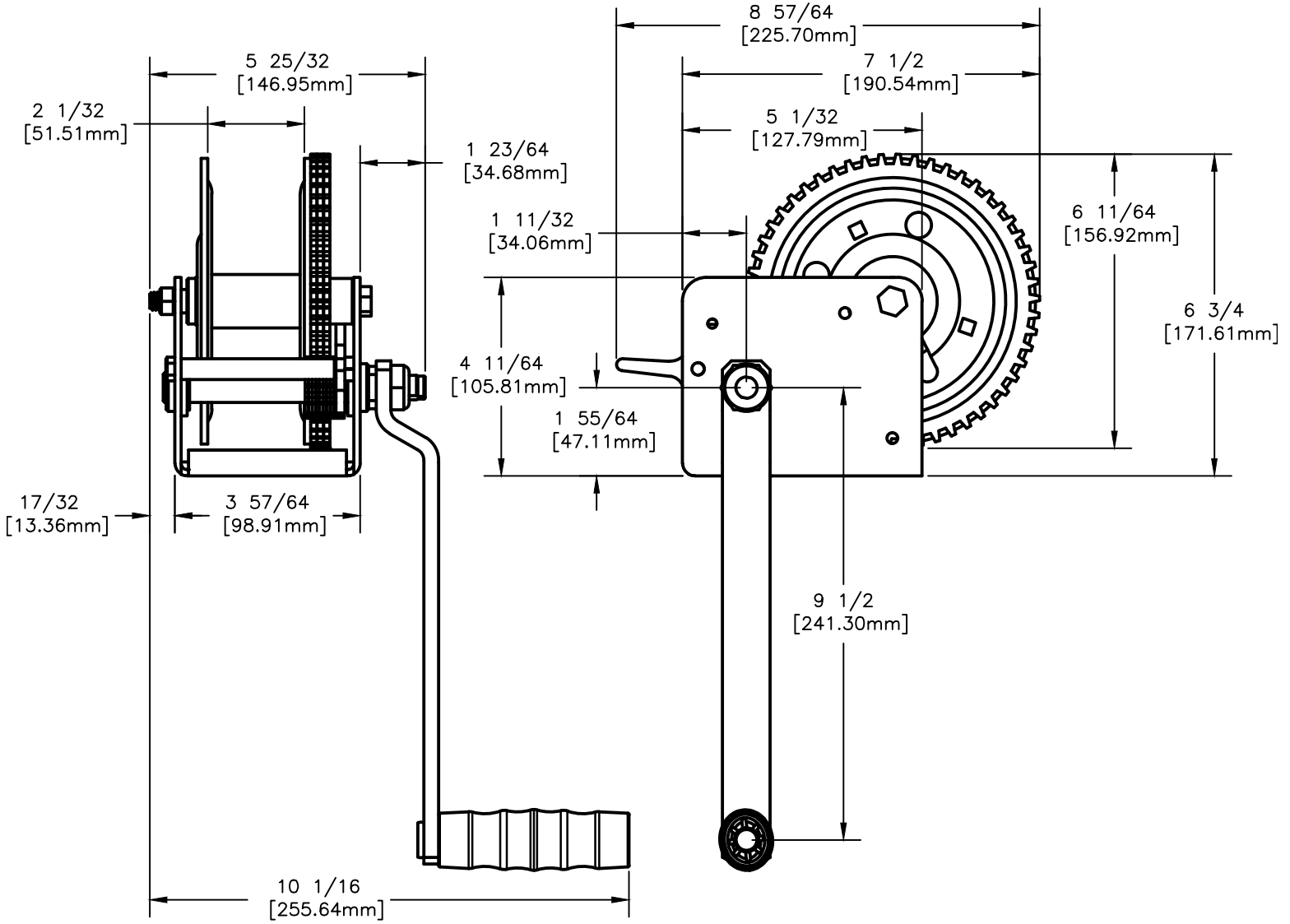

BASE HOLE PATTERN

