

FRONT & SIDE VIEW

MODEL DL1300A
 1300lb/590kg CAPACITY
 PULLING WINCH

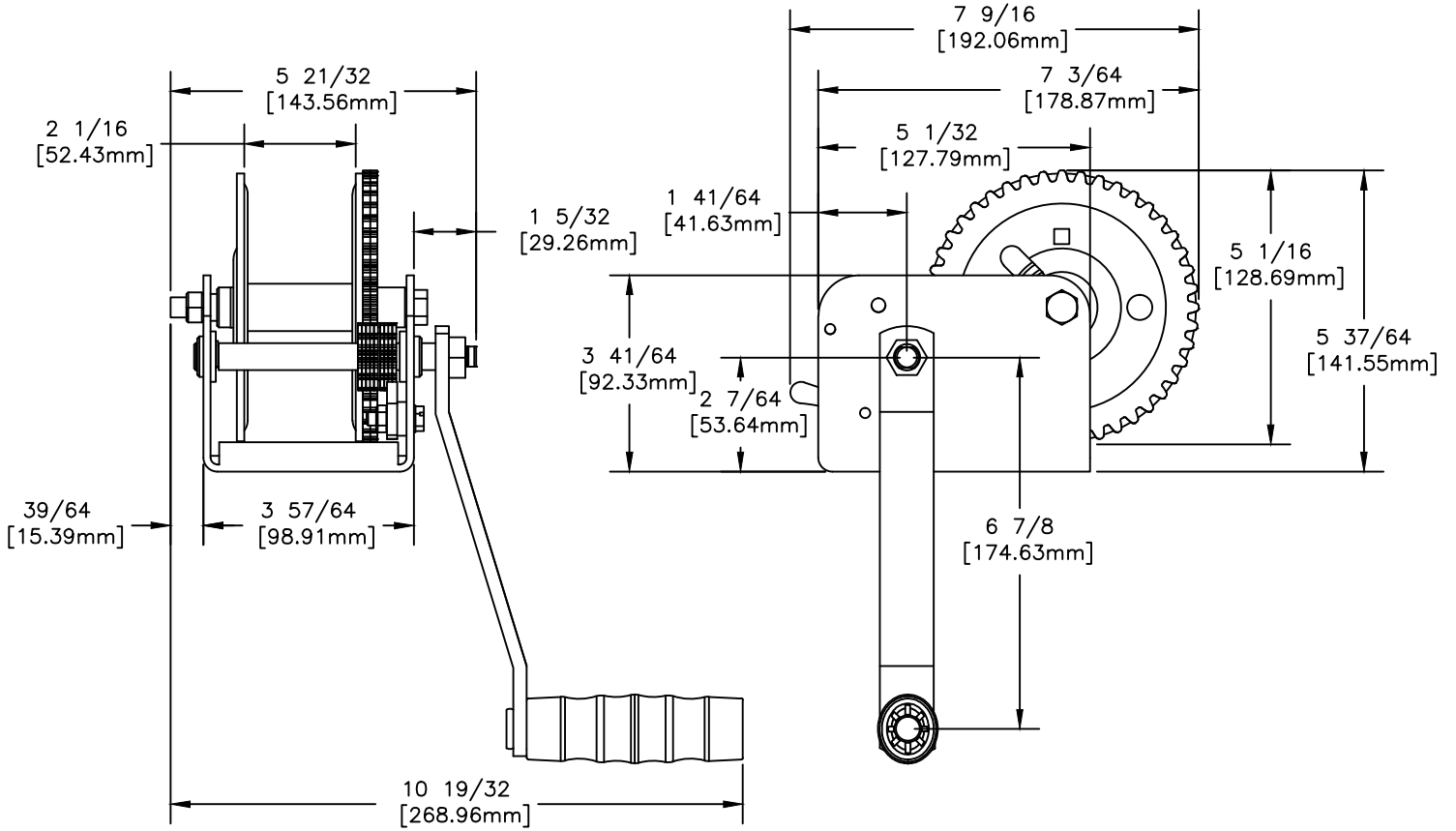

BASE HOLE PATTERN

